

ROBINIA PLAY



SOCIALIZING



CLIMBING



BALANCING



SLIDING



SWINGING



INFORMATION ABOUT THE PRODUCT







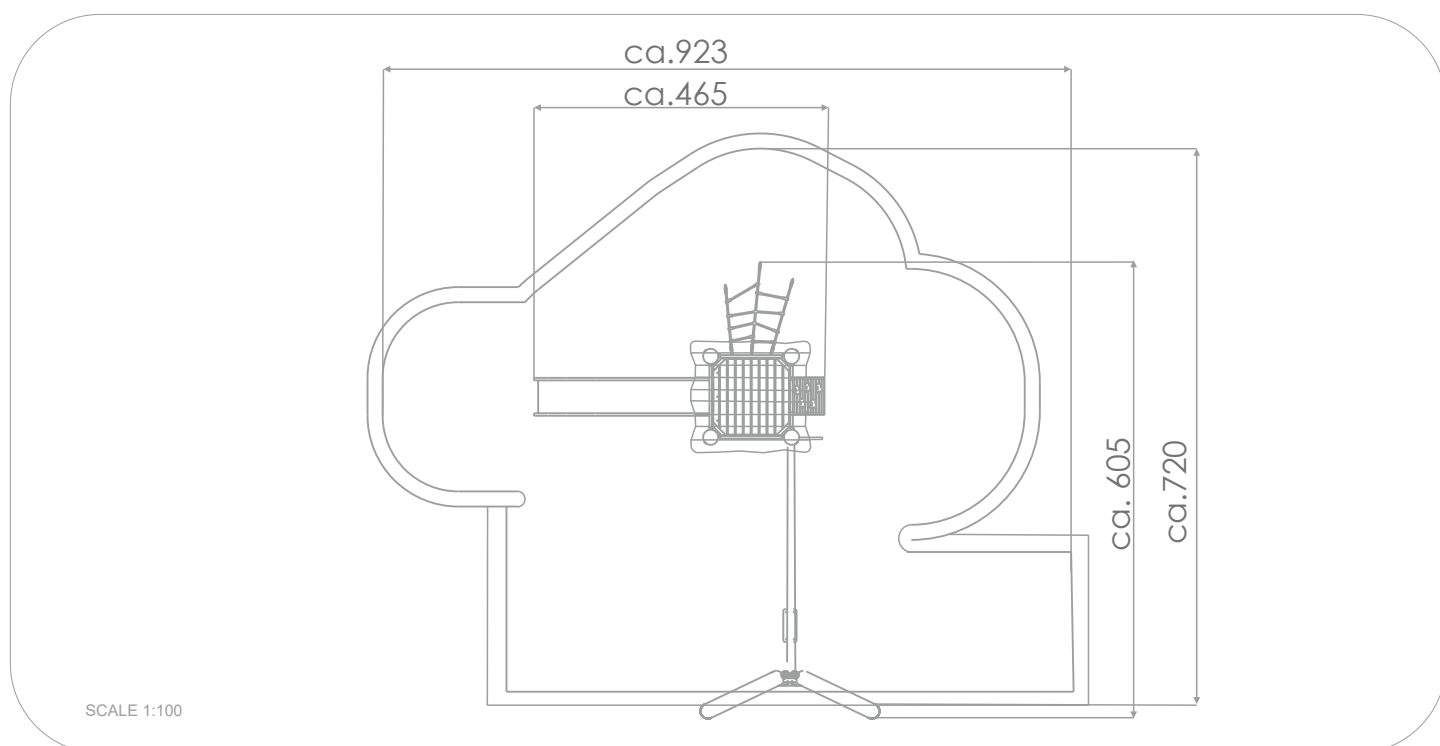
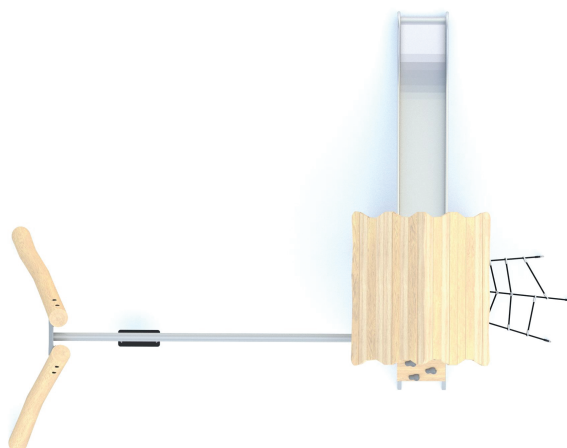



Dimensions	ca.605 x 465 cm
Safety zone	ca.720 x 923 cm
Overall height	ca.435 cm
Free fall height	ca.150 cm
Amount of users	6 person
Product complies with EN 1176-1:2017-12	YES
Availability of spare parts	YES
Age range	3-12

According to EN 1176-1:2017-12 norm, the product requires applying a safety surface according to the product's free fall height.

Visualisation is for reference only,
actual appearance may vary.

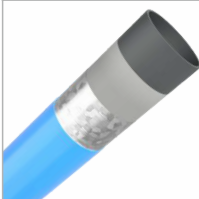

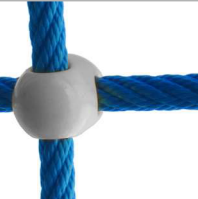
MATERIALS:

<p>NATURAL ROBINIA WOOD</p> 	<p>ELEMENTS CONSTRUCTION MADE OF STAINLESS STEEL AISI 304</p> 	<p>SLIDES MADE OF STAINLESS STEEL AISI 304</p> 	<p>SWINGS, SLINGS WITH DOUBLE BEARINGS MADE OF STAINLESS STEEL</p> 	<p>SEAT WITH A CONSTRUCTION MADE OF ALUMINIUM AND STAINLESS STEEL, DEDICATED FOR MOTHER AND CHILD</p> 	<p>BACK SUPPORT OF THE SEAT WITH STEEL CONSTRUCTION COVERED WITH SOFT POLYURETHANE</p> 
<p>SOLID CONSTRUCTION MADE OF BLACKSTEEL S235JR, CLEANED IN THE SANDBLASTING PROCESS</p> 	<p>POLYPROPYLENE ROPES PP - MULTISPLIT TYPE WITH A STEEL CORE AND A DIAMETER OF 16 MM</p> 	<p>ROPE ENDINGS PRESSED IN A SLEEVE MADE OF DURABLE ALUMINUM ALLOY</p> 	<p>SOLID AND ESTHETIC ROPE CONNECTORS MADE OF INJECTION MOLDED POLYAMIDE</p> 	<p>THE SEATS ARE MADE WITH AN ALUMINIUM CONSTRUCTION COVERED WITH A SOFT EPDM RUBBER</p> 	<p>SAFETY SEAT MADE OF ALUMINIUM AND STAINLESS STEEL COVERED WITH SOFT POLYURETHANE</p> 